



Transmitters Sensors



Pressure • Temperature • Humidity • Air velocity • Airflow





Transmitters

Features

Designed and manufactured in France, KIMO range of transmitters is perfectly suitable with any industry, process, building services, indoor climate, OEM...

KIMO offers many models: from the simplest to the most complete, adequate for any application, with easy configuration and calculation functions.

Innovating range: the interchangeable measuring elements enable easy maintenance and on-site calibration.

Housing	ABS - Aluminium
Display	LCD - Alphanumeric - Graphic
Configuration	DIP switch - Keypad - Software - Remote control
Outputs	Analog - Digital

- RCR relay
- MODBUS system
- Interchangeable measuring elements
- Calculation functions

Technology :

KIMO analog and digital measurement and output (Modbus communication system), can be **adapted on any existing or new installations.**





p.04

Monostats

Temperature
Humidity
Pressure

Class 50

p.05

Temperature
Humidity
Pressure



p.06

Class 100

Temperature
Temperature - Humidity
Pressure
Air velocity

Class 200

p.08

Temperature - Humidity
Pressure - Air velocity
Airflow



p.10

Class 300

Temperature - Humidity
Pressure
Air velocity - Airflow

Display

p.14

Temperature - Humidity
Pressure
Air velocity - Airflow



p.15

Akivision

Data Acquisition
System

p.16

Probes

Temperature

p.17

Useful info

p.18

Innovations

Of the range

Monostats

Applications
Refrigeration ■ Air conditioning

- ABS housing
- 5-digit LCD display
- Software or DIP switch configuration
- RCR relay
- Power supply 24Vac / Vdc

Thermostats

TST

Range from 0 to +50°C (TST-M)
 from -50 to +400°C (TST-B)
 Selection of units °C or °F



TST-M
Ambient



TST-B
Optional remote probe



TST-E
Waterproof



Humidistats

HST

Selection of units %RH, °C or °F
 Range from 0 to 100 %RH and
 from -20 to +80°C (HST-A / HST-D)
 or from 0 to +50°C (HST-M)



HST-D
Remote probe



HST-M
Ambient Sensor
Wall-mount



HST-A
Duct-mount

Manostats

PST

Selection of units Pa, mmH₂O, mbar,
 InWg, KPa and PSI

References	Ranges
PST-1	0-1000 Pa
PST-2	0-10 000 mmH ₂ O
PST-3	0-500 mbar
PST-4	0-2000 mbar



- ABS housing
- Easy and fast installation
- Software or DIP switch configuration
- Analog output

Temperature

TM50

Ranges from +10 to +40°C (TM50-A)
 from -50 to +400°C (TM50-B / TM50-E)
 Output Pt100 on terminal block
 Selection of units °C or °F



TM50-A
Ambient



TM50-B
Pt100 on terminal block
Optional probe

TM50-E
Airtight



Humidity

HM50

Range from 0 to 100 %RH
 Sensor ambient
 Selection of units %RH
 Output 4-20 mA or 0-10 V

Pressure

CP50

Range from 0 to 10 000 Pa (configurable range)
 Selection of units Pa, mmH₂O, mbar, InWg, mmHg
 Outputs 4-20 mA and 0-10 V





Temperature

TG100

Ranges from -20 to +80°C (duct-mount)
 -50 to +400°C (Pt100 on terminal block)
Selection of units..... °C or °F
Output..... 4-20 mA ou 0-10 V



TG100
 Pt100 on terminal block
 (Optional probe)



TG100
 Duct-mount



TM100

Ranges from -20 to +80°C (airtight)
 from 0 to +50°C (ambient sensor)
Selection of units..... °C or °F
Output..... 4-20 mA or 0-10 V



TM100
 Ambient sensor
 (wall-mount)



TM100
 Airtight



Temperature Humidity

TH100

Ranges from 0 to 100 %RH and from -20 to +80°C
Selection of units..... %RH, °C or °F
Output..... 4-20 mA or 0-10 V



TH100
 Duct-mount



TH100
 Standard sensor

TH100
 Remote probe

Class 200

Applications
Industries ■ Laboratories



- Visual alarm (LED)
- Graphic display
- Software or keypad configuration
- RS 232 digital output for external transmitter
- ABS housing - IP65
Easy and fast installation

- With or without display
- Calculation functions
- 2 RCR relays



configurable



OUTPUTS

Configurable Analog outputs

Pre-configured or configure by yourself: the outputs are automatically adjusted to the new range.

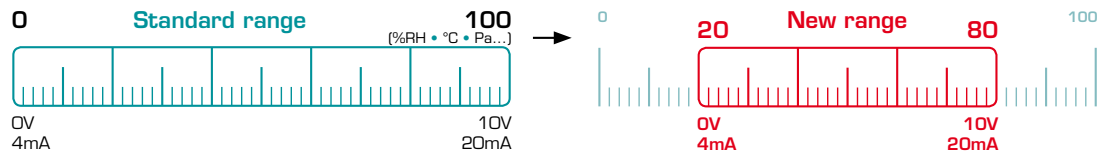

Pressure

CP200

References Ranges

CP201	0-1000 Pa
CP202	0-10 000 Pa
CP203	0-500 mbar
CP204	0-2000 mbar

Connectionbarbed or compression fittings
 Selection of unitsPa, mmH₂O, mbar, InWg, mmHg, KPa and PSI
 Outputs2 x 4-20 mA or 2 x 0-10 V

Functions:

- Pressure
- Air velocity
- Airflow with Pitot, Debimo...
- Manual auto-zero
- Measurement integration
- Measuring correction factor
- Temperature compensation



Accessories for airflow

- DEBIMO measuring blades
- Pitot Tubes with integrated temperature probe



SQR/2 function (optional)

Air velocity and airflow calculation in duct from the differential pressure.
 Learn more p.19



Temperature / Humidity

TH200

Ranges from 0 to 100 %RH and -40 to +180°C
Probe Standard or remote (see below)
Selection of units %RH, g/Kg, KJ/Kg, °C and °F
Output 2 x 4-20 mA or 2 x 0-10 V

Functions:

- Temperature
- Wet bulb temperature
- Enthalpy
- Relative humidity
- Absolute humidity
- Dew point calculation

Stainless steel or PC probes

- PTFE sintered tip
- Protective plastic head
- Stainless steel perforated head
- Stainless steel sintered tip



On-site calibration

The EHK 500 is a referenced portable calibrator. Simply connect the RS232 connection cable and adjust humidity measurement.

Learn more p. 18

Interchangeable probes

TH200/CTV210/CP200

- Unclip
- Clip
- Measure!

Smart-PRO System

Easy and fast change of measurement element. Automatic recognition.

Learn more p. 19



Made of

Stainless steel
Polycarbonate

Ranges

-40 to +180°C (SS)
-20 to +120°C (PC)

Probes

Standard
Remote

Lengths

100 mm
150 mm
300 mm



Air velocity / Airflow

CTV210

Ranges from 0 to 30 m/s and from 0 to +50°C
Probe stainless steel hotwire (length 150mm or 300mm and 2m of cable)
Selection of units m/s, fpm, °C, °F, m³/h, m³/s, L/s, cfm
Outputs 2 x 4-20 mA or 2 x 0-10 V

Functions :

- Measuring correction factor
- Air velocity
- Airflow

Class 300

Applications
Industries ■ Laboratories



- Visual alarm LED
- Digital display
- Software or keypad configuration
- Digital input for external transmitter
- Alu or ABS housing. Easy and fast installation.



- 2 contacts / RCR relays
- With or without display
- Digital communication
- Calculation functions



Interchangeable probes Unclip - Clip - Measure!

Easy and fast change of measurement element. Automatic recognition.
[Learn more p. 19](#)

MODBUS network

Class 300 transmitters can be linked in one network, on a RS 485 modbus. They can also be integrated into an existing network.

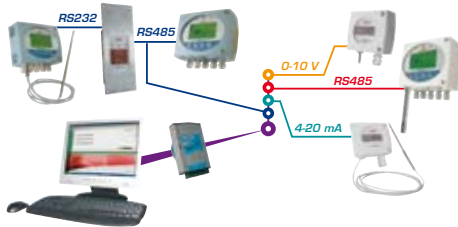

Configurable analog outputs

Pre-configured or configure by yourself: the outputs are automatically adjusted to the new range.

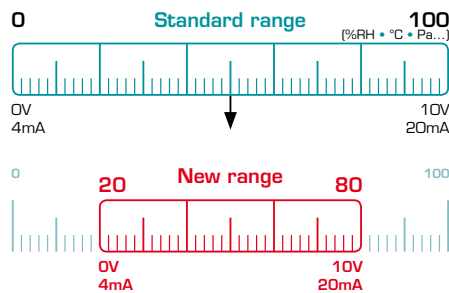

Air velocity / Airflow

CTV310

Rangesfrom 0 to 30 m/s and 0 to +50°C
 Probestainless steel hotwire (lg. 150mm or 300mm and 2m of cable)
 Selection of unitsm/s, fpm, °C, °F, m³/h, m³/s, L/s, cfm
 Outputs2 x 4-20 mA or 2 x 0-10 V

Functions :

- Measuring correction factor
- Air velocity
- Airflow

Temperature / Humidity

TH300

Ranges from 0 to 100 %RH and -20 to +120°C (PC)
 from 0 to 100 %RH and -40 to +180°C (SS)
Probe standard or remote
Selection of units %RH, g/Kg, KJ/Kg, °C and °F
Outputs 2 x 4-20 mA or 2 x 0-10 V
Length 100mm / 150mm / 300mm

Functions:

- Temperature
- Wet bulb temperature
- Enthalpy
- Relative humidity
- Absolute humidity
- Dew point calculation



THA300

Ranges from 0 to 100 %RH and -20 to +120°C (Polycarbonate)
 from 0 to 100 %RH and -40 to +180°C (Stainless Steel)
Probe standard or remote
Selection of units %RH, g/Kg, KJ/Kg, °C and °F
Output 2 x 4-20 mA or 2 x 0-10 V
Length 100mm / 150mm / 300mm

Functions:

- Relative humidity
- Absolute humidity
- Dew point calculation
- Wet bulb temperature
- Temperature
- Enthalpy



On-site calibration TH300/THA300

The EHK 500 is a referenced portable calibrator. Simply connect the RS232 connection cable and adjust humidity measurement.

Learn more p. 18

Stainless steel or PC probes TH300/THA300

- PTFE sintered tip
- Protective plastic head
- Stainless steel perforated head
- Stainless steel sintered tip



Pressure

CP300



Connection barbed
Selection of units Pa, mmH₂O, mbar, InWg
Outputs 2 x 4-20 mA or 2 x 0-10 V and RS 232

References	Ranges
CP301	0-100 Pa
CP302	0-500 Pa
CP303	0-1000 Pa
CP304	0-10 000 Pa

Functions:

- Pressure and air velocity
- Airflow with Pitot, Debimo
- Airflow with other coefficients
- Measurement integration
- Self-calibration
- Measuring correction factor
- Temperature compensation: manual or automatic (thermocouple K input)

CPE300



CPE300
 Brushed
 stainless
 steel

CPE300
 White lacquered
 stainless steel

Installation flush-mount or wall-mount
Connection barbed
Selection of units Pa, mmH₂O, mbar, InWg
Outputs 4-20 mA or 0-10 V and RS 232

References	Ranges
CPE301	0-100 Pa
CPE302	0-500 Pa
CPE303	0-1000 Pa

Functions:

- Air velocity
- Airflow
- Measuring correction factor
- Infrared remote control for configuration

Alternative display

Via the RS 232 connection, the CPE300 can display alternatively, in addition to the pressure, other parameters such as temperature and humidity from a TH200 for example.

Alternative



DISPLAY



Front calibration

Enables you to adjust and calibrate your transmitters directly on site or in laboratories.

Learn more p.18





CPA300

Connection barbed
Selection of units Pa, mmH₂O, mbar, lnWg
Outputs 2 x 4-20 mA or 2 x 0-10 V and RS 232

Functions:

- Pressure
- Air velocity
- Airflow with Pitot, Debimo...
- Manual or automatic
- Measurement integration
- Measuring correction factor
- Temperature compensation

References Ranges

References	Ranges
CPA301	0-100 Pa
CPA302	0-500 Pa
CPA303	0-1000 Pa
CPA304	0-10 000 Pa



CPA ZC

Ranges from -100 to +100 Pa and -1000 to +1000 mmH₂O
Outputs 4-20 mA or 0-10 V
Relays 2 to 4 RCR relays 6A / 230 Vac
Display LED display with color graduation and digital display of the measure

Functions:

- Pressure
- Air velocity
- Airflow with Pitot, Debimo...
- Manual or automatic
- Measurement integration
- Measuring correction factor
- Temperature compensation



Airflow accessories

- DEBIMO measuring blades
- Pitot Tubes with integrated temperature probe

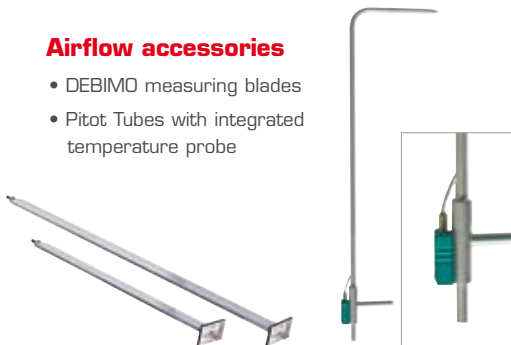

SQR function (optional)

Calculation of air velocity and airflow from the differential pressure.

Learn more p.19



Display

Applications

Refrigeration ■ Air-conditioning ■ Industries
 ■ Building services, indoor climate ■ ...

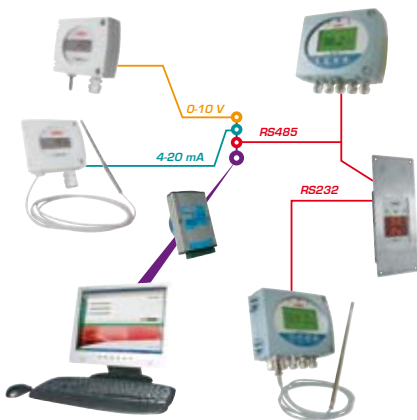

- Easy and fast installation
- Configuration by infrared remote control
- Digital communication

**RS
232**



MODBUS system

Our new range of transmitters can be managed within a **Modbus network (RS 485 system)**. You can also integrate our transmitters to your existing network.

Pre-programmed measuring units:

- Pressure
- Airflow
- Air velocity
- Temperature
- Humidity
- ...



Large display

ATT300

Display	from -9 999 to 99 999
Display of the reading	5 matrix digits (H. 53 mm)
Display of units	4 digits / 14 segments (H. 12,7 mm)
Input	digital for external transmitter
Analog inputs	3 x 4-20 mA or 3 x 0-10 V



Compatibility of current/voltage inputs

Can work with any current or voltage input of any transmitter: pressure, humidity, temperature, airflow, air velocity...

Multi-channel flush-mount display

ATE300

Can be installed flush-mounted or wall-mounted.

Display	from -999 to 9 999
Display of the reading	4 digits / 7 segments (H. 14,22 mm)
Display of units	4 digits / 14 segments (H. 12,7 mm)
Input	digital for external transmitter
Analog inputs	3 x 4-20 mA ou 3 x 0-10 V

Alternative display

Alternating display of 1 to 3 parameters (eg. humidity, temperature and pressure).

Alternative



DISPLAY



Data Acquisition System



Applications

AKIVISION data acquisition system was specially developed to monitor air movement conditions. It is perfectly suitable for process monitoring and control of air parameters: Temperature Humidity - Pressure - Air Velocity - Airflow. AKIVISION data acquisition system is also in adequation with applications of many fields such as food-processing industry, service and industry.

Akivision

AKIVISION software allows to configure, record and display data in real time, and also to process all data measured by KIMO transmitters and probes.

Akivision CFR

NEW

AKIVISION CFR is the key software for all users who require traceability, as per «21 CFR part 11» norm. Security and integrity of data are guaranteed; no possibility to modify or tamper with data.

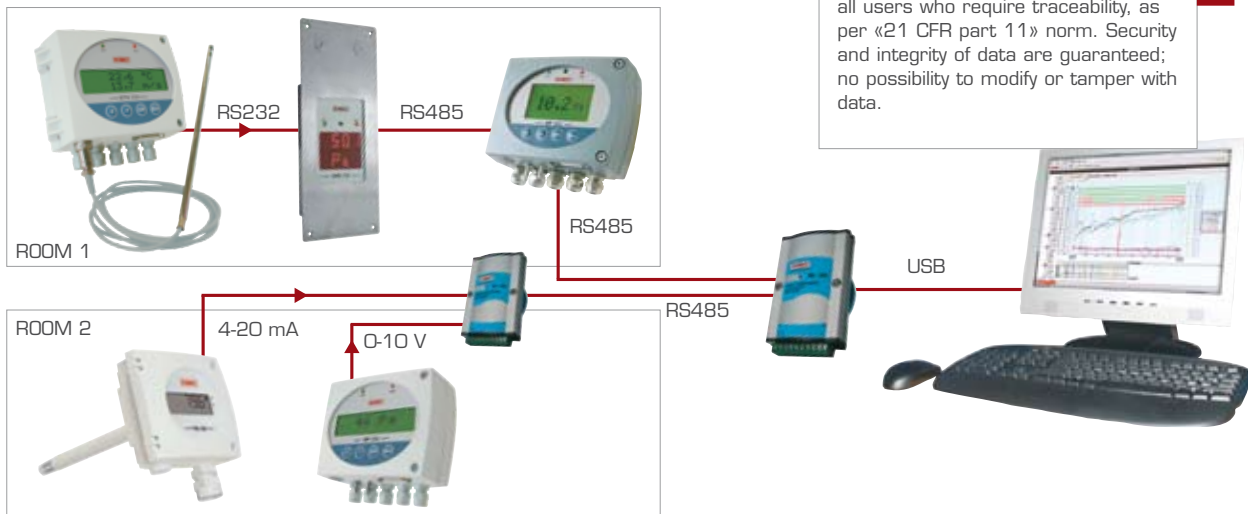

Akivision A

Version A AKIVISION software enables to configure all transmitters and modules of your installation, and to record and display measurements in real time.



- Configuration of instruments & modules
- Users acces management
- Configuration of acquisition
- Display of acquisition

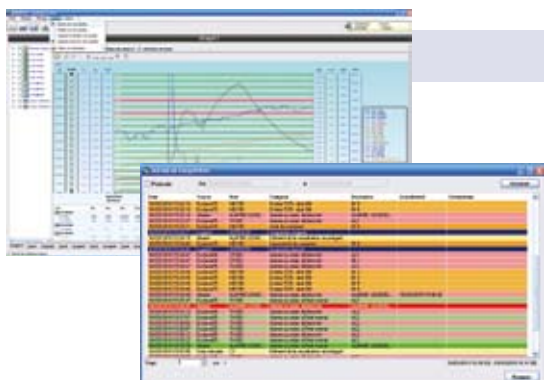

Akivision E



Version E AKIVISION software easily enables to process, consult, analyze and print all measured data.

- Data processing & exportation
- Alarms log
- Remote lookup & display of your records

Temperature probes

Standard or custom-made probes

- Thermocouple K, J, T, N
- Pt100 / Pt1000 probes
- NTC probes

Your need: your probe

Because your application is specific, we manufacture your customized probe.

CONTACT US !



Connection head

Alu / Noryl / Stainless steel head

Stainless steel, heat resisting steel or mineral insulated sheath, Alard coating ...
Single pair or multipair

References

TBCT

TBEIK

TPTT-50

TBARK

...

Features

For pipe contact

With interchangeable probe system

For aggressive application

With heat-resisting steel protector



Wire probes

PVC / Silicon / Teflon® / Glass silk cable

Stainless steel hose
Wire mounting: 2, 3, 4, 6 wires
(single pair or multipair)

References

F-50

SFR-50

SFKI

...

Features

Output DIN connector

With fixing fitting

With cable



Accessories

Converters

Mounting brackets

Thermowells

Watertight connections

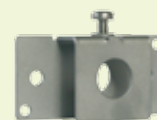

Useful information

Humidity transmitters

Capacitive humidity sensor

Principle: the dielectric constant of the humidity sensor varies according to the ambient humidity. This information is then relayed to the transmitter and converted to a digital signal. The measuring signal is not affected by the ambient pressure.

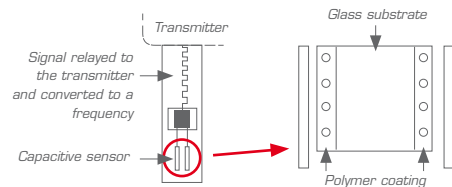

Digital humidity sensor

Principle: the dielectric constant of the humidity sensor varies according to the ambient humidity. This information is then relayed by the micro-controller to the transmitter and converted to a digital signal.

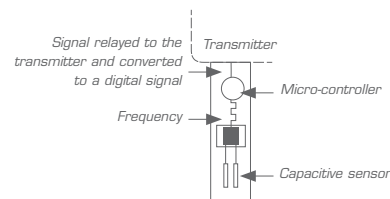

Temperature transmitters

Pt100

Principle: a Pt100 sensor is a resistance, with positive temperature coefficient, which varies according to the temperature. The value of the resistance varies according to the increase of the temperature.

For 0°C ≈ 100 Ω
For 100°C ≈ 138,5 Ω



Thermocouple K

Principle: a thermocouple works thanks to voltage drop across dissimilar metals which are placed in contact. This voltage is a function of the measured temperature.

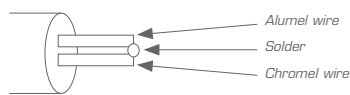

Pressure transmitters

Principle

A pressure transmitter (piezoresistive type) makes a voltage proportional to the pressure on the transmitter.

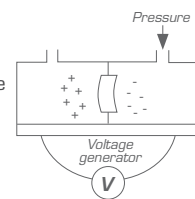

Airflow calculator

From air velocity

Principle: airflow is calculated from the air velocity multiplied by the surface of a grille or a duct.

$$\text{Airflow} = \text{Velocity} \times \text{Area}$$

Air velocity can be calculated from the differential pressure

$$\text{Velocity} = \text{Coef} \times \sqrt{\text{Pressure}}$$

Power supply

Transmitters with Passive loop

Principle: the transmitter is supplied with a continuous voltage => we measure the current used by the transmitter. This current varies between 4 and 20 mA, proportionally to the measured parameter (pressure, temperature, relative humidity...).

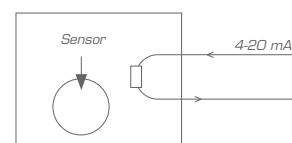

Active transmitter

Principle: the transmitter provides a current (4-20 mA) or a voltage (0-10 V) loop. It can work in either direct (DC) or alternative current (AC). The power supply connected to the transmitter enables it to generate a current of 4-20 mA or a voltage of 0-10 V proportional to the measured parameter.

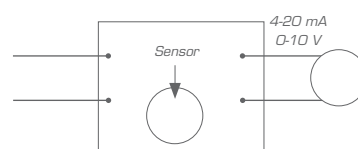

Calibration

Front calibration

CPE300

No need to remove the transmitter or to modify the initial connection.

Calibration



On-site calibration

Class 200/300

The EHK 500 is a referenced portable calibrator. Simply connect the RS 232 connection cable and adjust humidity measurement.

Time-saving: no need to return the transmitter to our After Sales-Service. You can adjust the unit yourself.



Self-calibration

Class 300

You can enable or disable the self-calibration system.



Compensation in temperature

Class 200/300

This probe allows to measure and display the temperature and/or to compensate the calculation formula of the transmitter in real time, for a better accuracy.

Compensation is guaranteed by the permanent adjustment of the zero. Then, differential pressure measurement is done whichever the environmental conditions of the transmitters are.

Housings

Installation

Quick and easy with the "1/4 turn" system.



Connection

Connection and maintenance are simple to carry out thanks to the hinged cover.



Safety

Installation secured

Locking system with access code, to secure the installation.



Electromagnetical

The KIMO transmitters comply with the EMC norm.



Configuration

DIP Switch

Stats, classes 50/100

Set the units, measuring ranges and type of analog output.

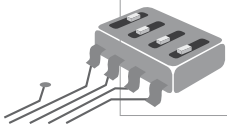

Keypad

Class 200/300

With only 4 keys you can easily configure the transmitter. You can also modify the units, ranges (defined at our factory), relays, set points, alarms, time-delays, outputs, channels.



Remote control

Class 300

Recommended when configuring transmitters that are hard to reach.



Software

For our whole range of transmitters

The easiest way to configure the units, ranges, relays, alarms, time-delays, outputs, channels, set points...



Digital communication

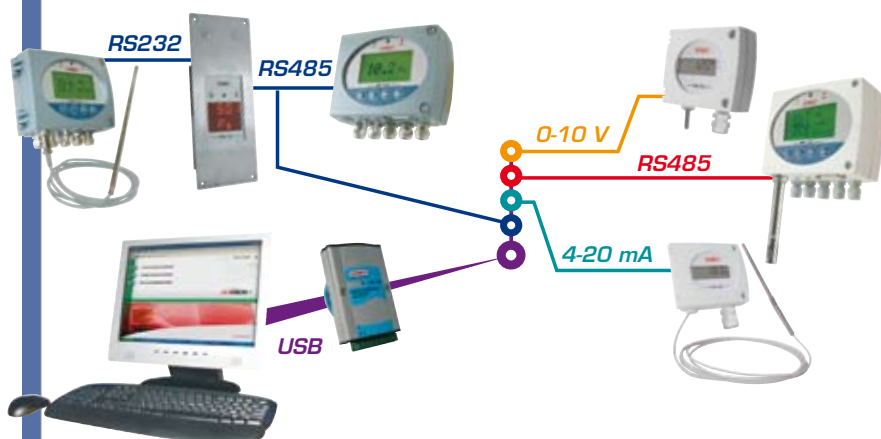

MODBUS

Class 300

Digital communication.
Easy access to data and configuration.

Our new range of transmitters can be managed within a Modbus network (RS 485 system). You can also integrate our transmitters to your existing network.

RS232 communication

Class 200/300

Via the RS232 connection, TH 300 can display 1 or 2 parameters that are measured by others KIMO Class 200 and 300 transmitters.
Benefit: the TH 300 can display (in addition to the humidity and temperature) other parameters such as pressure, air velocity or airflow from a CP200 for example.

**RS
232**

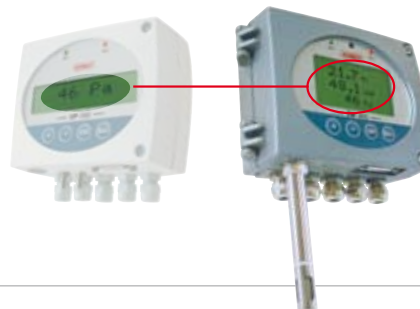

Measurement elements

Smart-PRO system

Class 200/300

Smart-Pro



System

Unclip / Clip / Measure !

Easy and fast change of measurement element, for user-friendly maintenance.
The new numeric Smart-Pro probes are fully interchangeable, individually adjusted and automatically recognized by the instrument when being connected.

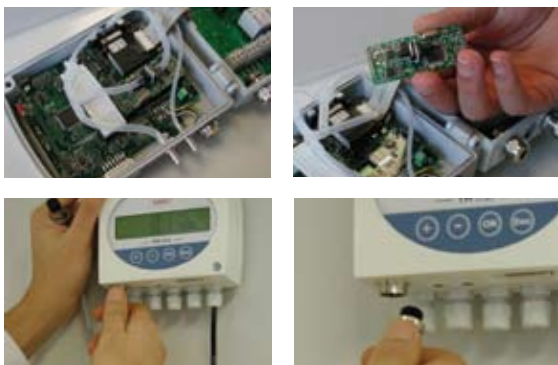

SQR/2 function

Pressure transmitters working with a differential probe (such as DEBIMO, Pitot tube, orifice plate...) can be configured with a square root function. Via this function, and from the differential pressure, the transmitter can calculate air velocity and/or airflow in a duct.

**SQR/2
Fonction**

Airflow accessories

- DEBIMO measuring blades
- Pitot Tubes with integrated temperature probe

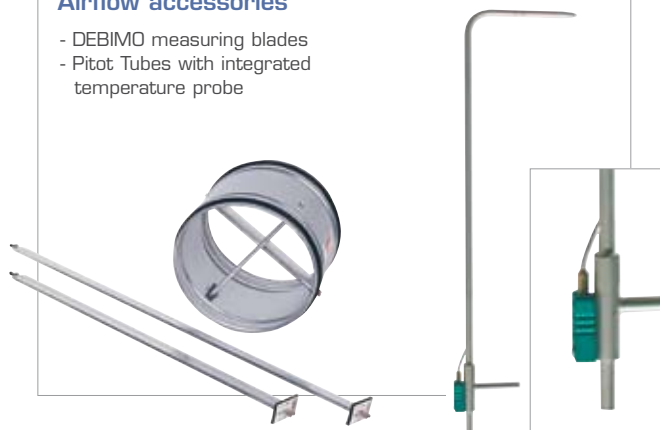



Distributed by:



www.kimo.fr



KIMO - Export Department
Boulevard de Beaubourg - BP 48
Emerainville - F-77312 MARNE LA VALLEE Cedex 2 - France
Tel.: +33 1 60 06 69 25 - Fax: +33 1 60 06 69 29
Email: export@kimo.fr